

# Two Way Time Transfer Results at NRL and USNO

Ivan J. Galysh and G. Paul Landis  
Naval Research Laboratory  
Code 8152  
4555 Overlook Ave. S.W.  
Washington D.C.20375-5354

## Abstract

*The Naval Research Laboratory (NRL) has developed a two way time transfer modem system for the United States Naval Observatory (USNO). Two modems in conjunction with a pair of Very Small Aperture Terminal (VSAT) and a communication satellite can achieve sub nanosecond time transfer. This performance is demonstrated by the results of testing at and between NRL and USNO. The modems use Code Division Multiple Access (CDMA) methods to separate their signals through a single path in the satellite. Each modem transmitted a different Pseudo Random Noise (PRN) code and received the others PRN code. High precision time transfer is possible with two way methods because of reciprocity of many of the terms of the path and hardware delay between the two modems. The hardware description was given in a previous paper [1].*

## Introduction

Three different experiments were performed with the time transfer modems. The first experiment was to verify that the basic operations of the modem were satisfactory. The second experiment was to determine the performance level of the modems. The third test came about because of problems in the second experiment.

## Experiments

The first experiment was to determine how well the modems would operate through a satellite. Figure 1 shows the diagram of the configuration. Both modems operated from a common clock source. The two modems transmitted on the same VSAT through a combiner module. The received signal was split to the two modems.

There were two purposes to performing this experiment. The first was to determine how repeatable the modems were in determining the time difference. The second was to determine how well the modems re-synchronized to their one Pulse Per Second (PPS) signal. Tests were run over 6 days with typically two sessions in a half hour of satellite time.

The results show that the modems performed quite well in the experiment configuration. The standard deviation on the second to second time transfer of a single session was no higher than 205 picoseconds with a typical level of about 170 picoseconds as shown in Figure two. The time transfer

between modems was repeatable to within 0.5 nanoseconds peak to peak (Figure 3) with a noise level of about 144 picoseconds. The modems did re-synchronize themselves within 0.5 nanoseconds peak to peak (Figures 4 and 5). The variations in the re-synchronizing were probably due to the long rise times of the 1 PPS signal (Figure 6).

The second experiment was to perform a series of two way time transfers between NRL and USNO. NRL is located about seven miles from USNO and line of sight time transfer methods between the two locations have been used for years. Each location contains a variety of atomic clocks and the performance of the clocks and the time transfer link has been well documented. This configuration provides an almost perfect method of independently verifying the time transfer performance of the modems. Figure 7 shows the block diagram of the modem configuration.

A second measurement system used for verification is shown in Figure 8. The channel 5 television transmitter carrier from WTTG is synchronized to a cesium frequency standard. The carrier signal is received by both NRL and USNO and compared with a local signal synthesized from the house reference but offset from the carrier by 2250 Hz. The 2250 Hz beat is detected at both ends and USNO sends its beat over a dedicated phone line as a 2250 Hz tone. The tone is compared with the beat generated by the NRL system using a phase meter. Resolution is better than 1 nanosecond with a noise level of about 2 nanoseconds. This system is based on the work described in reference 2.

Figure 9 shows the plot of the time difference between NRL and USNO using the modems along with the time difference measurements using the other system. The modem measurements are plotted on the solid line. The channel 5 data is plotted on the dotted line. Figure 10 shows the difference of these two measurements. Figure 11 shows the one second noise plot of the experiment. The long period of no data is where satellite time could not be allocated. The channel 5 measurement system data was offset to match the start of the modem data. The modem tracked the channel 5 measurements somewhat, but not accurately enough. After the experiment, it was determined that a piece of equipment supplying the 5 MHz and 1PPS to the modem at NRL malfunctioned.

With equipment problems corrupting the second experiment, a third experiment was devised. The third experiment took place at USNO using their base station antenna and a VSAT. Both modems were placed side by side. Each was connected to its own cesium standard and individual antenna (Figure 12). This allowed direct measurements on the two modems with a time interval counter. The cesiums were intentionally offset. On each time transfer, the time difference between the two clocks was measured. This measurement was compared with the data generated by the modems. Figure 13 shows the plot of the modem data and the time interval counter. The solid line is the modem measurements. The dotted line is the time interval counter measurements. With the drift of the two clocks and the procedures of measuring the time differences, the peak to peak extremes were within two nanoseconds as shown in Figure 14. The noise level was 528 picoseconds. Since the two modems had never been calibrated this also shows that the absolute calibration of the two modems is very close.

Figure 15 shows the one second data plot of the modem operating on the VSAT. Its noise is at 275 picoseconds. The plot of the earth station data is shown in figure 16. The data is much noisier at 1535 picoseconds. The reason for this is that the earth station is transmitting more power to

the satellite than the VSAT. The satellite retransmits the signal back along with the VSAT signal. The earth station modem has to extract the smaller VSAT signal from its own larger signal. It's own signal appears as a noise source. Figure 17 shows the difference plot of the previous two plots with a noise level at 798 picoseconds approximately half the larger one way noise.

## Conclusion

The first experiment has shown that the modem can re-synchronize themselves repeatable at less than 500 picoseconds. The last experiment has shown that the modems can do precise time transfers. More experimentation is needed to see just how precise the modems can be.

## References

- [1] G. Paul Landis and Ivan Galysh, "*NRL/USNO Two Way Time Transfer Modem Design and Results*", IEEE Frequency Control Symposium, Hershey Pennsylvania, 27-29 May 1992, pp. 317-326.
- [2] A. Gabry, G. Faucheron, B.Dubouis and P. Petit, "*Distance Comparison of Stable Frequency Standards by Means of the Transmission of a Beat Note Between the Carrier of a TV Broadcast Signal and a Frequency Synthesized from the Frequency Standard*". 31st Annual Symposium on Frequency Control, Atlantic City, New Jersey, 1-3 June 1977

# Colocated Time Transfer Configuration

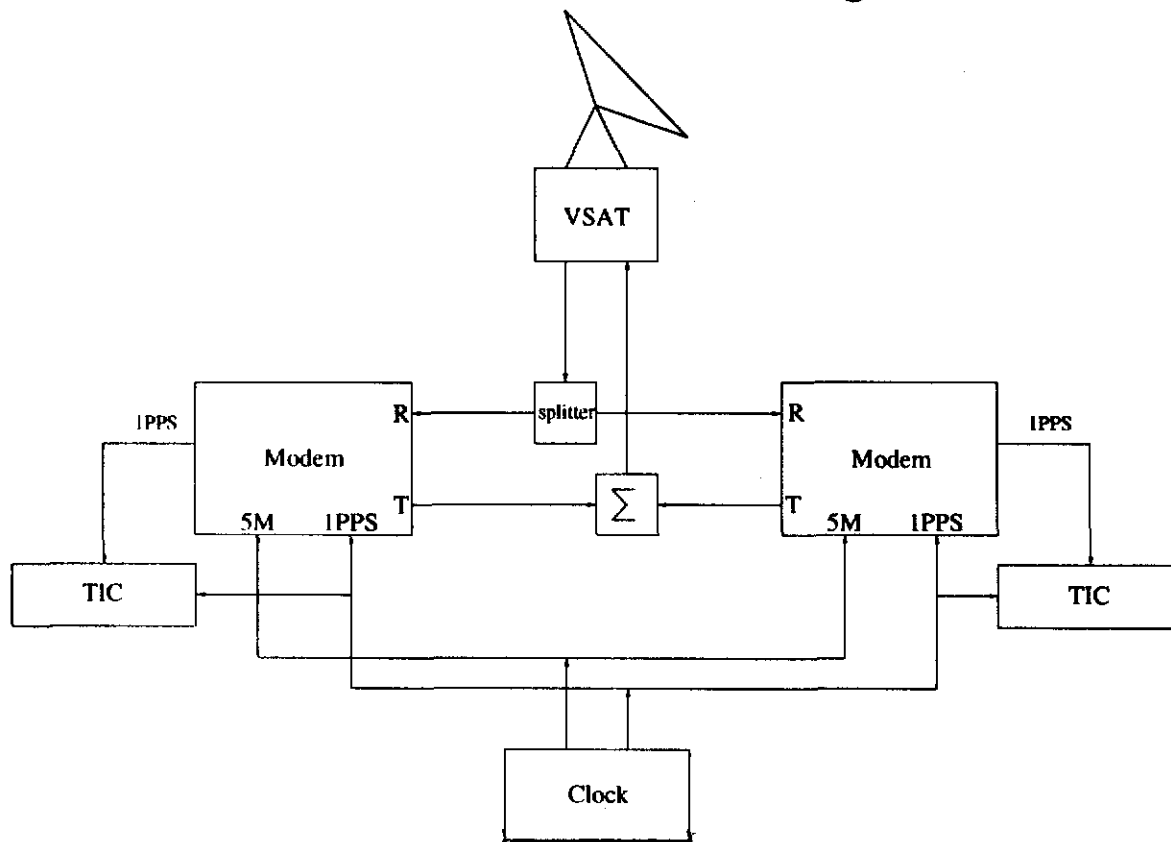
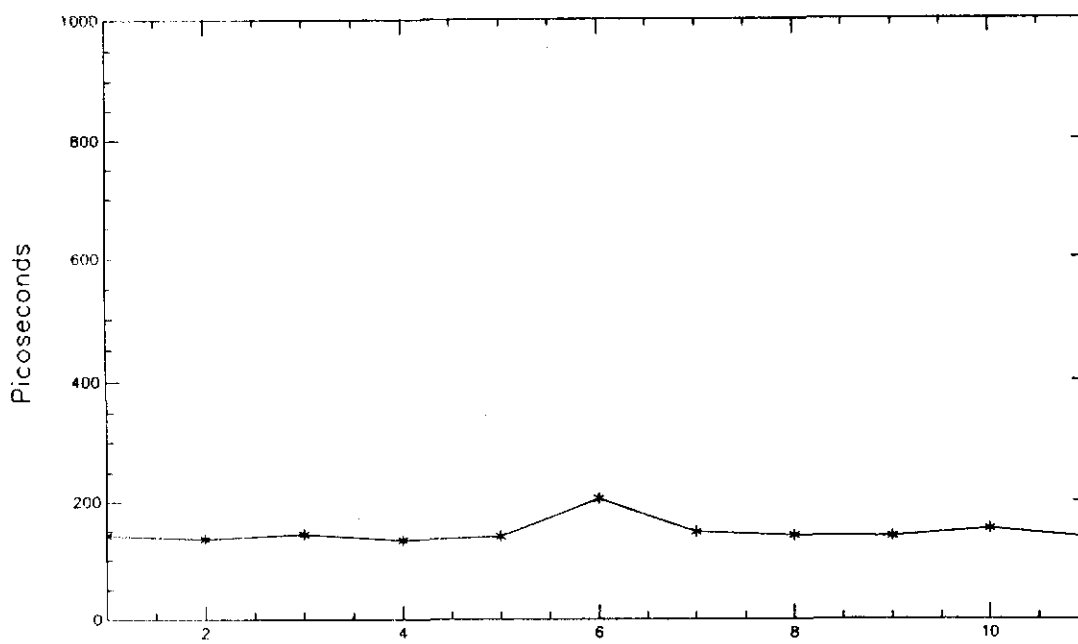

Figure 1.  
Colocated Time Difference, One Second Noise



Run  
Figure 2.

Colocated Time Difference (300 Seconds)

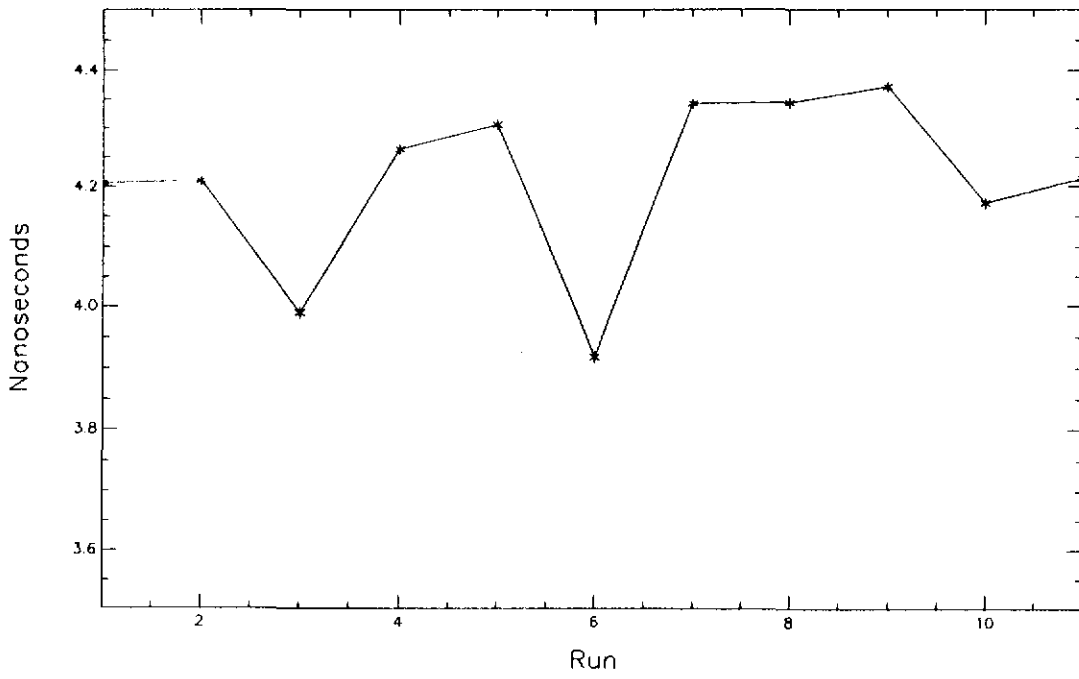

Figure 3.

1PPS out - 1PPS in, Left Modem

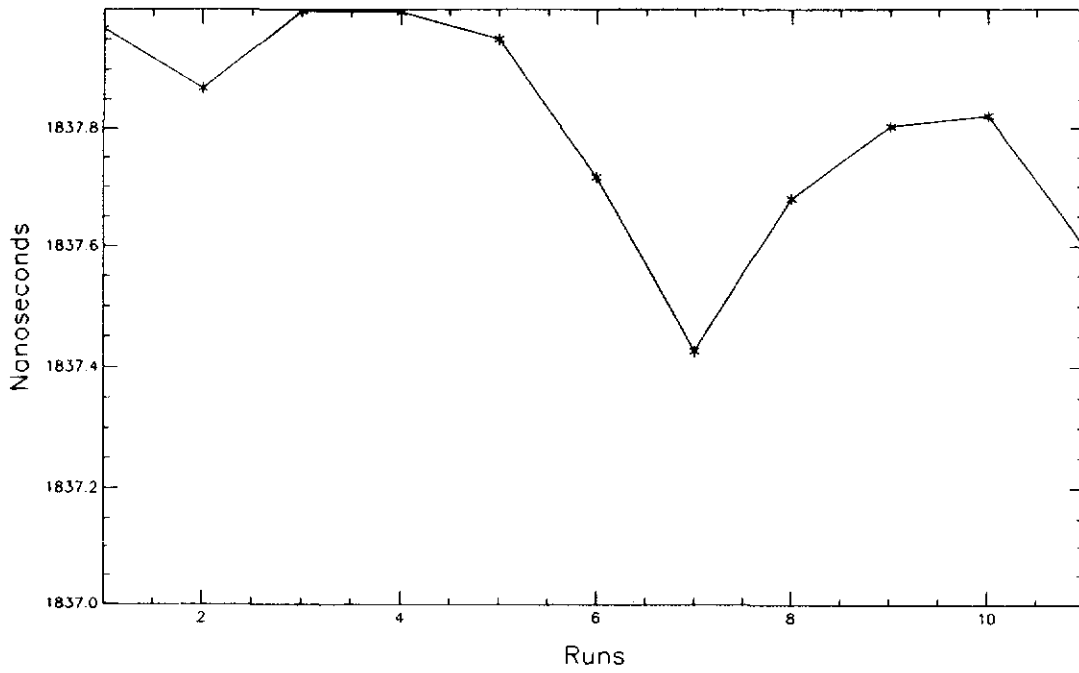

Figure 4.

1PPS out - 1PPS in, Right Modem

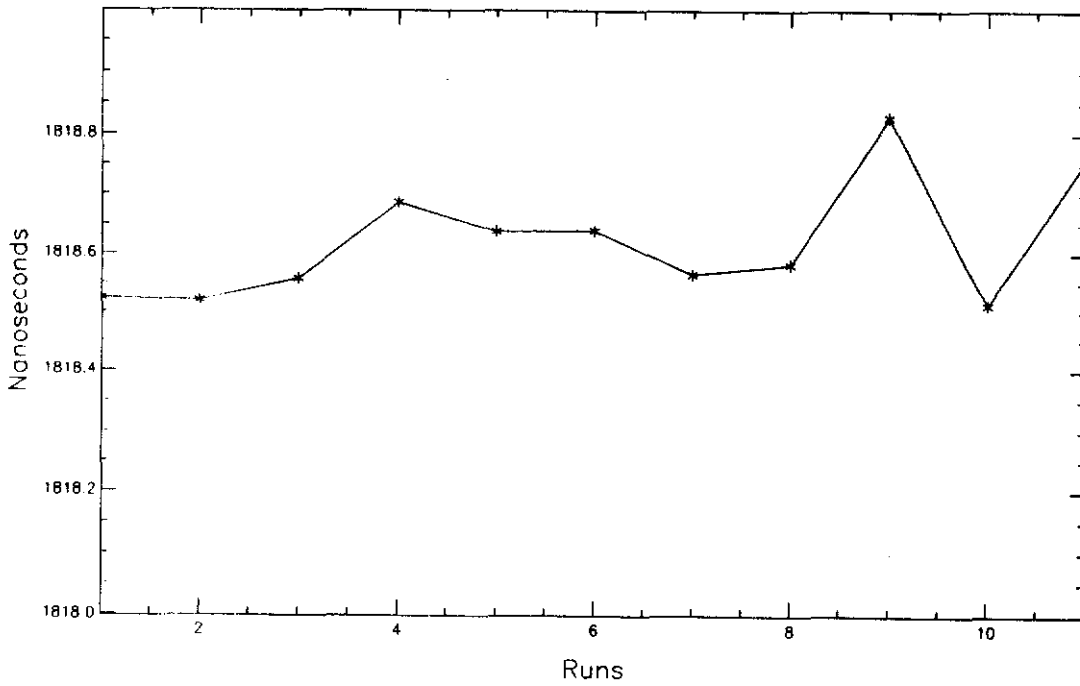

Figure 5.

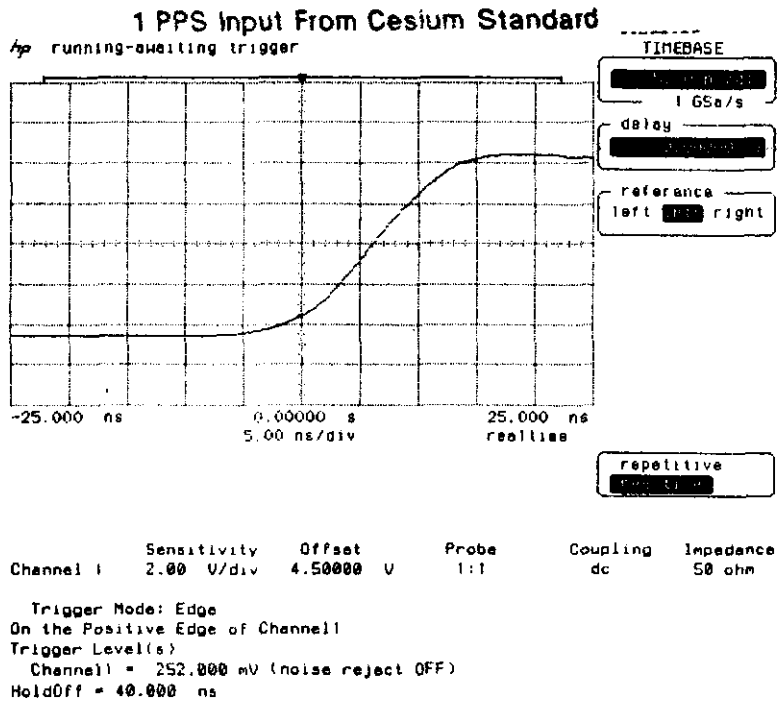

Figure 6.

## Two Way Time Transfer NRL/USNO

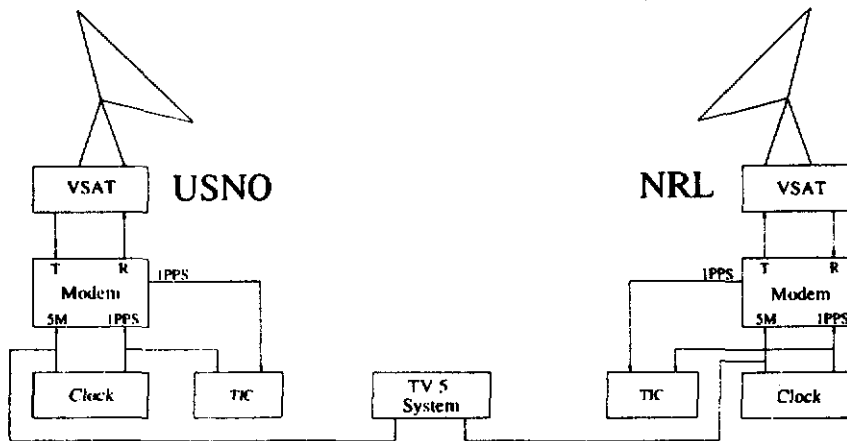
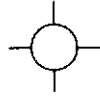

Figure 7.

## Channel 5 Measurement System

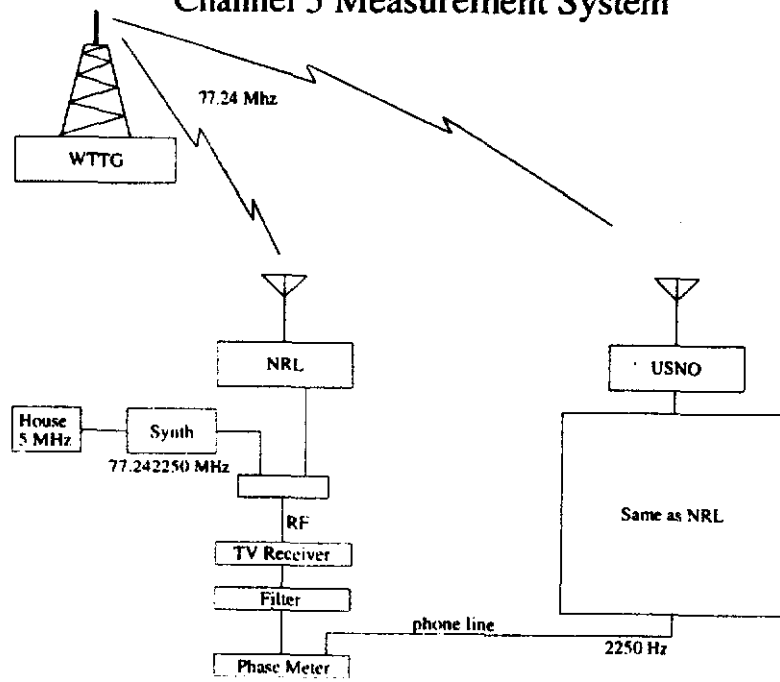

Figure 8.

Modem and TV 5 data

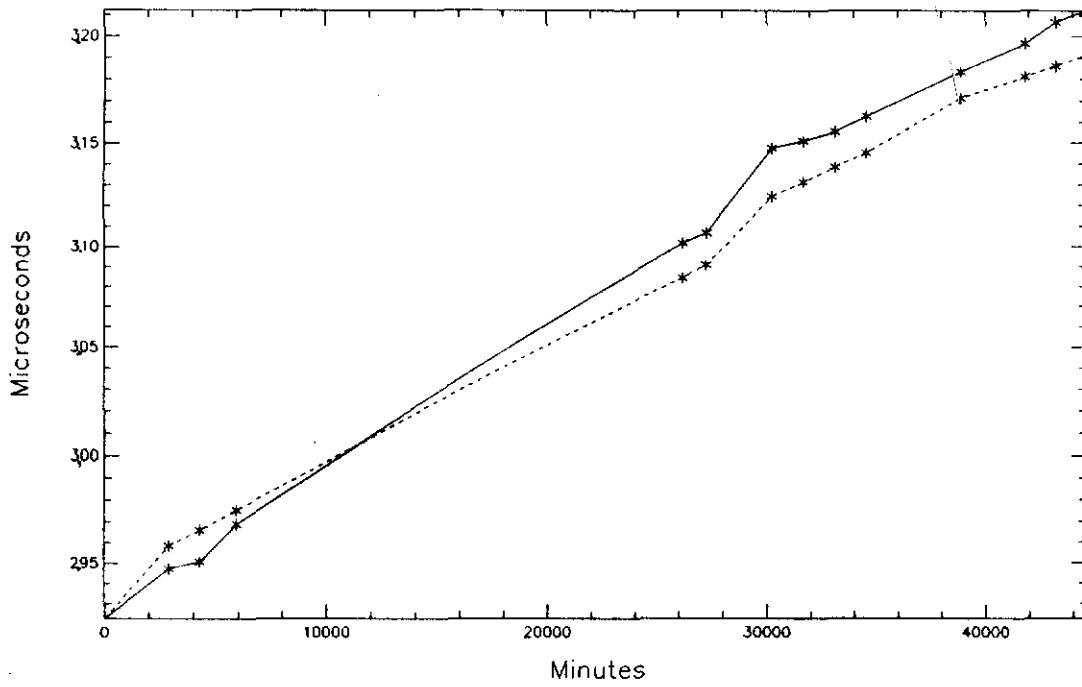

Figure 9.

Modem - TV 5 data

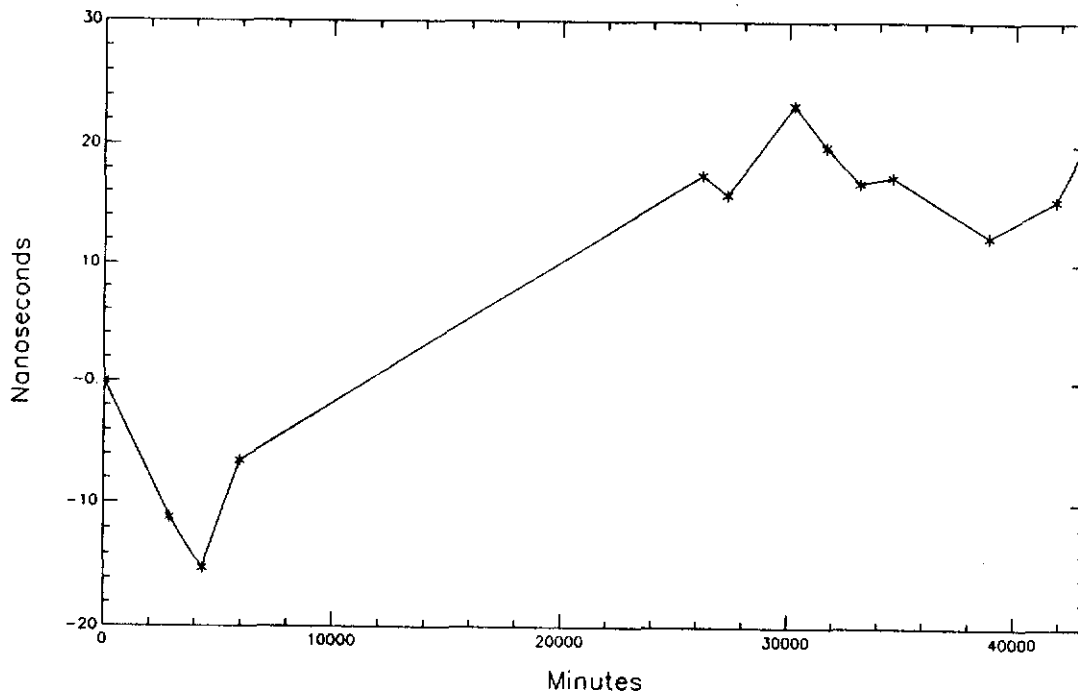

Figure 10.



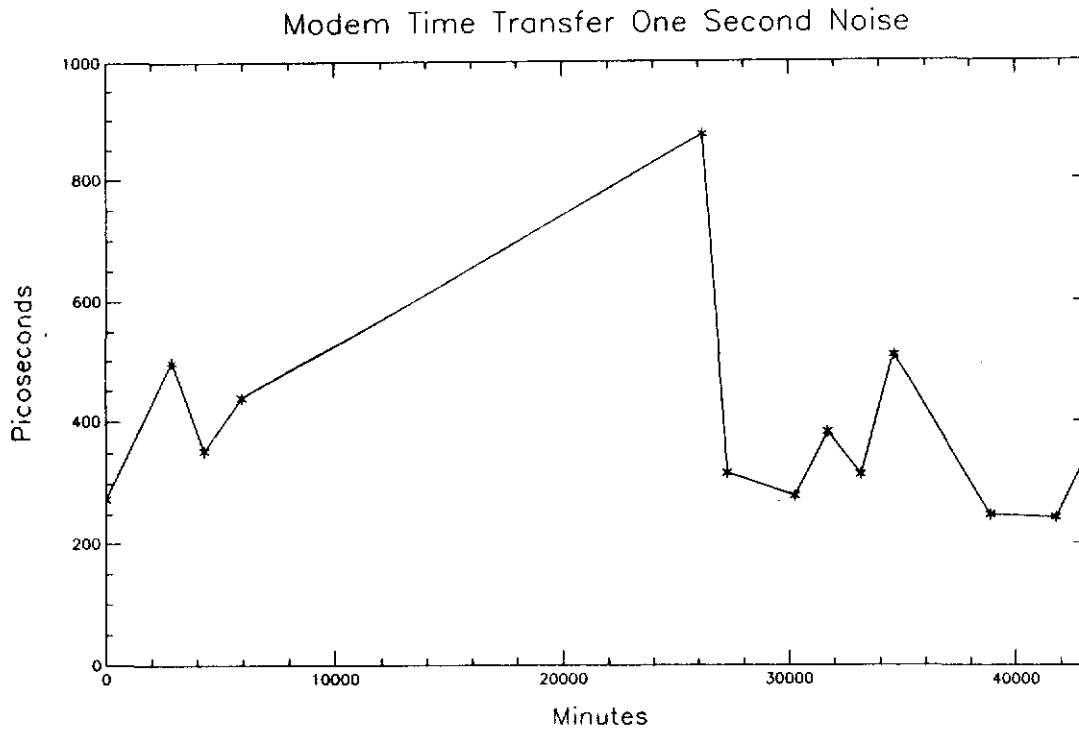

Figure 12.

### Two Way Time Transfer

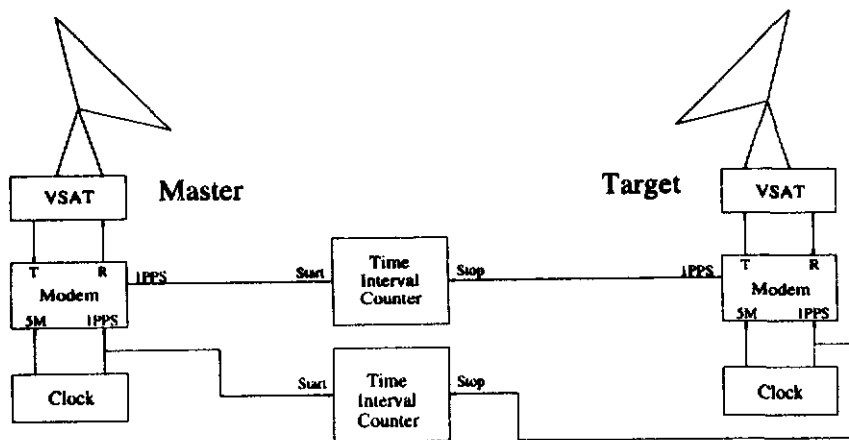

Figure 11.

Two Way Time Transfer, Modem output and Measurements

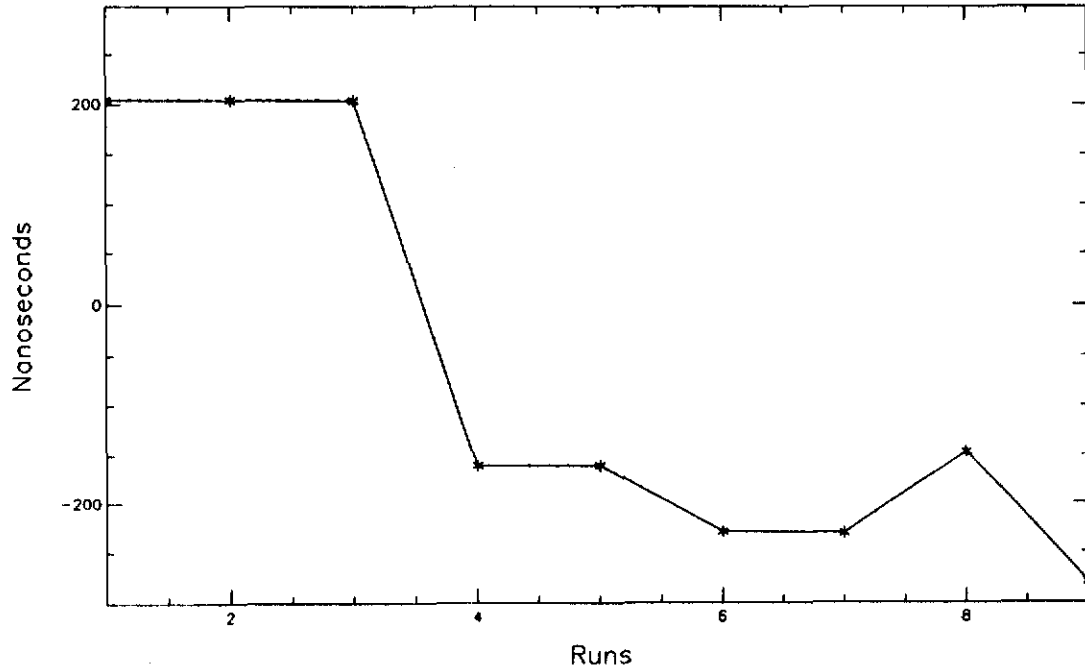

Figure 13.

Modem 1PPS out - Measurement

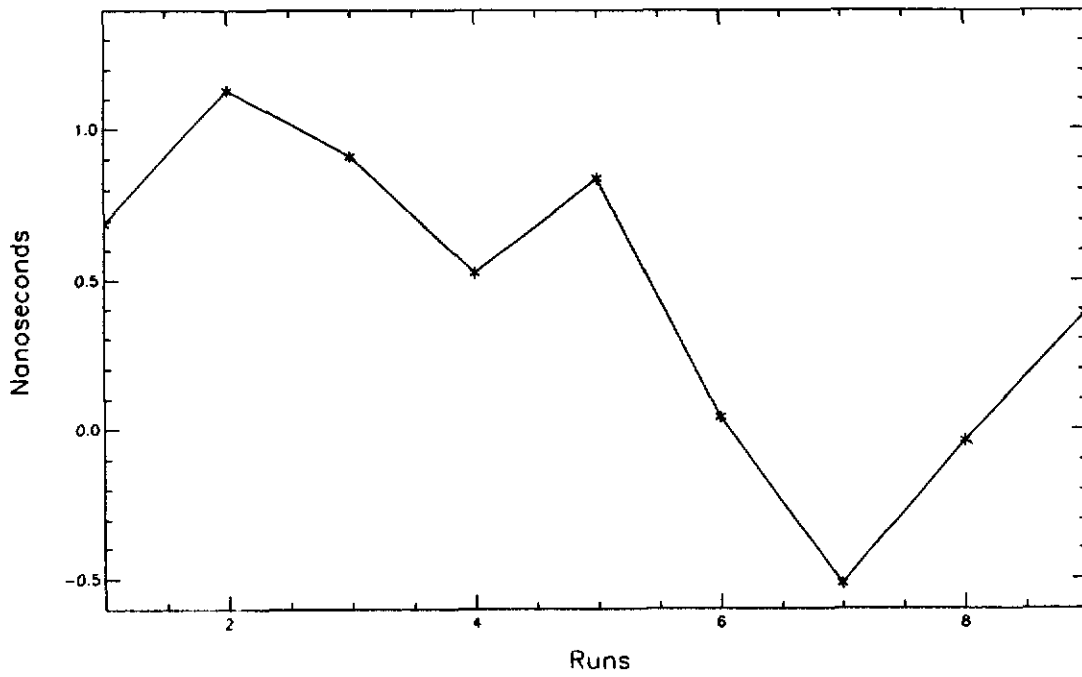
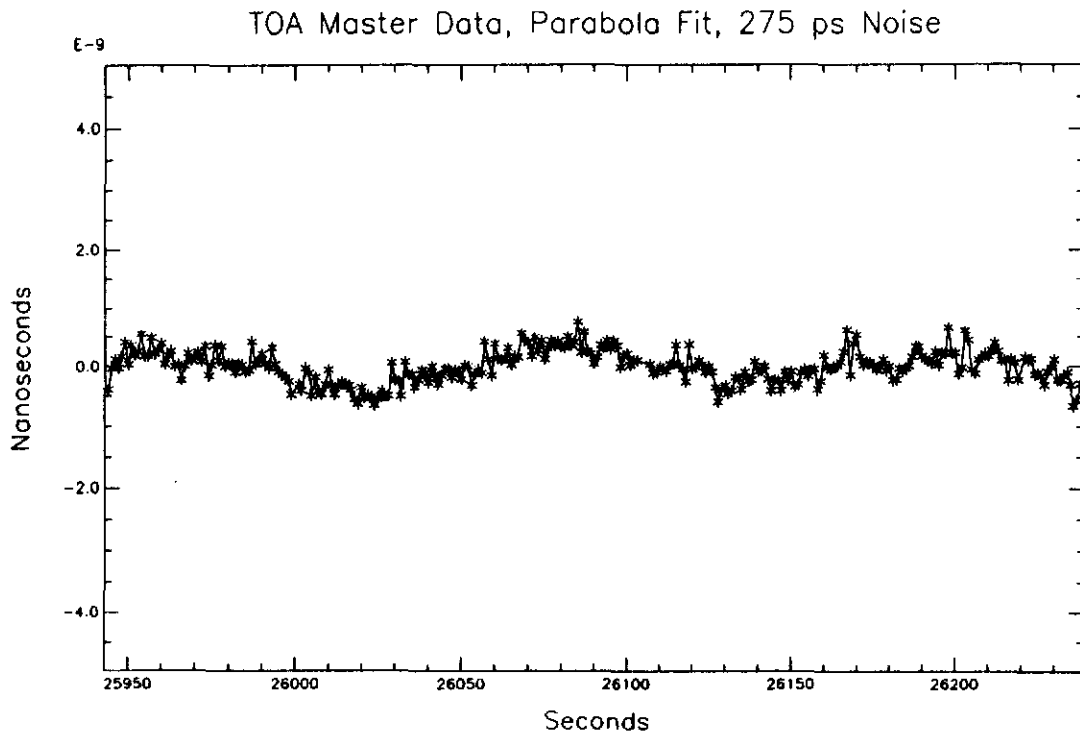
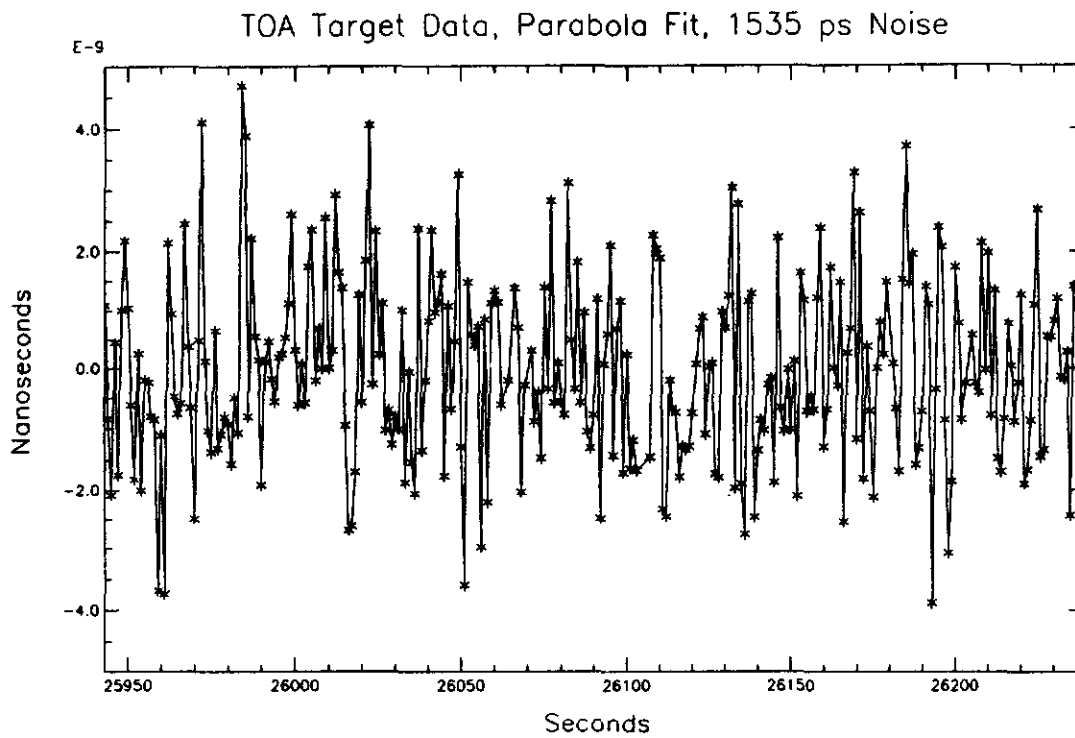

Figure 14.



**Figure 15.**



**Figure 16.**

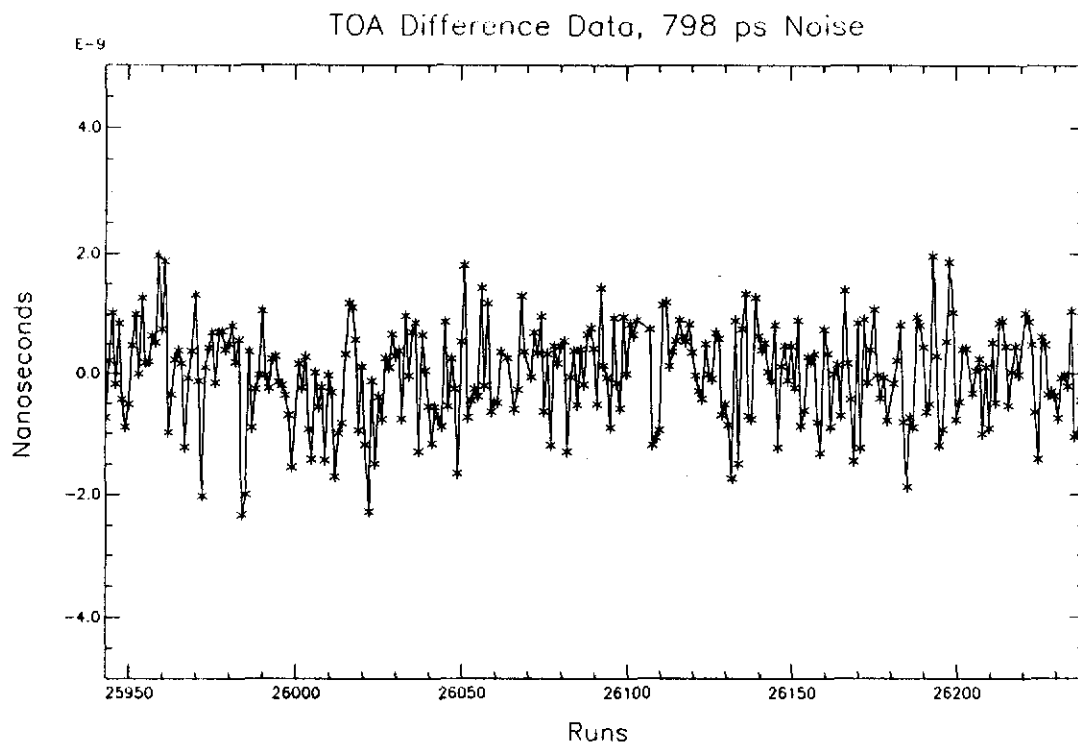

Figure 17.